

STAND-NESTC-60 - ADJUSTABLE FLIP-TOP TABLE

Product Specifications:

Item Number	Stand-NestC-60
Dimensions	59" W x 23.6" D x 30" – 45.25" H
Table Material	Particle board with Melamine Top; PVC edge banding
Color Finish	Gray
Table Dimensions	59" W x 23.6" D x 0.17" H
Leg Material	Steel
Grommet Holes	Two; 2" diameter
Weight	91 lbs.
Adjustable Height Increments	Any height between 30" – 45.25" H
Height Adjustment Mechanism	Crank
Flipping Mechanism	Bar with two handle pulls
Casters (4)	3" furniture casters; two locking brakes
Weight Capacity	150 lbs.
Ship Method	Freight
Shipping Carton Dims	63" W x 28" D x 7" H
Shipping Weight	100 lbs.
Meets ANSI/BIFMA	Yes
Assembly Required	Yes

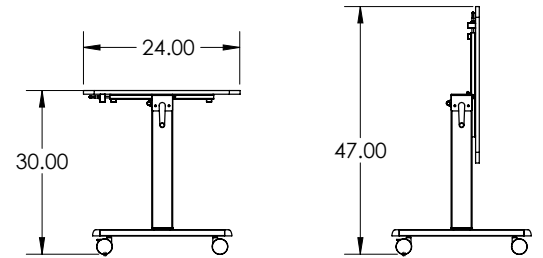
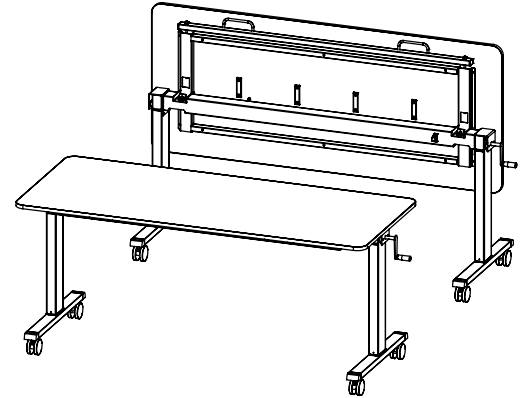

To Order, Call Your Sales Representative or 800-323-4656