

Charging Cart Instructions

03/29/17

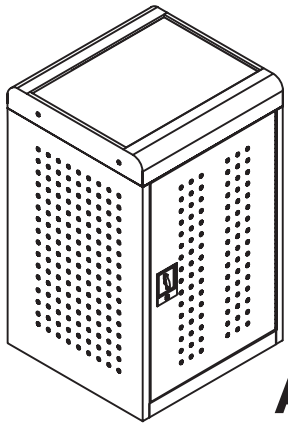

A x1

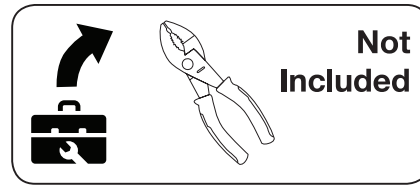
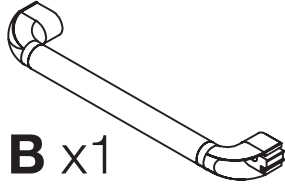

B x1

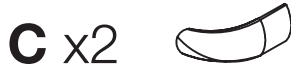

C x2



D x1

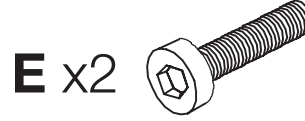

E x2

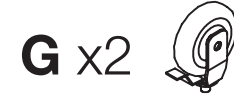

G x2



J x1



F x1



H x2



K x1



L x2

1

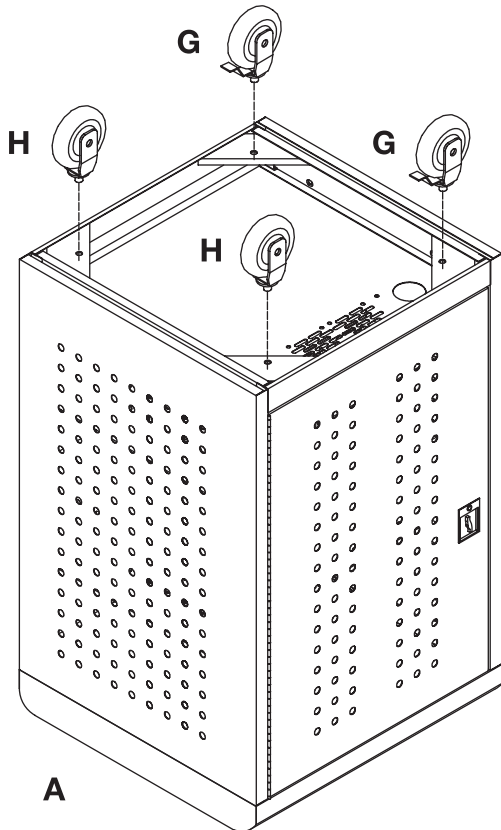

2



**Heavy Lifting:
Assistance
Required**

